

17 $\varepsilon = ?$

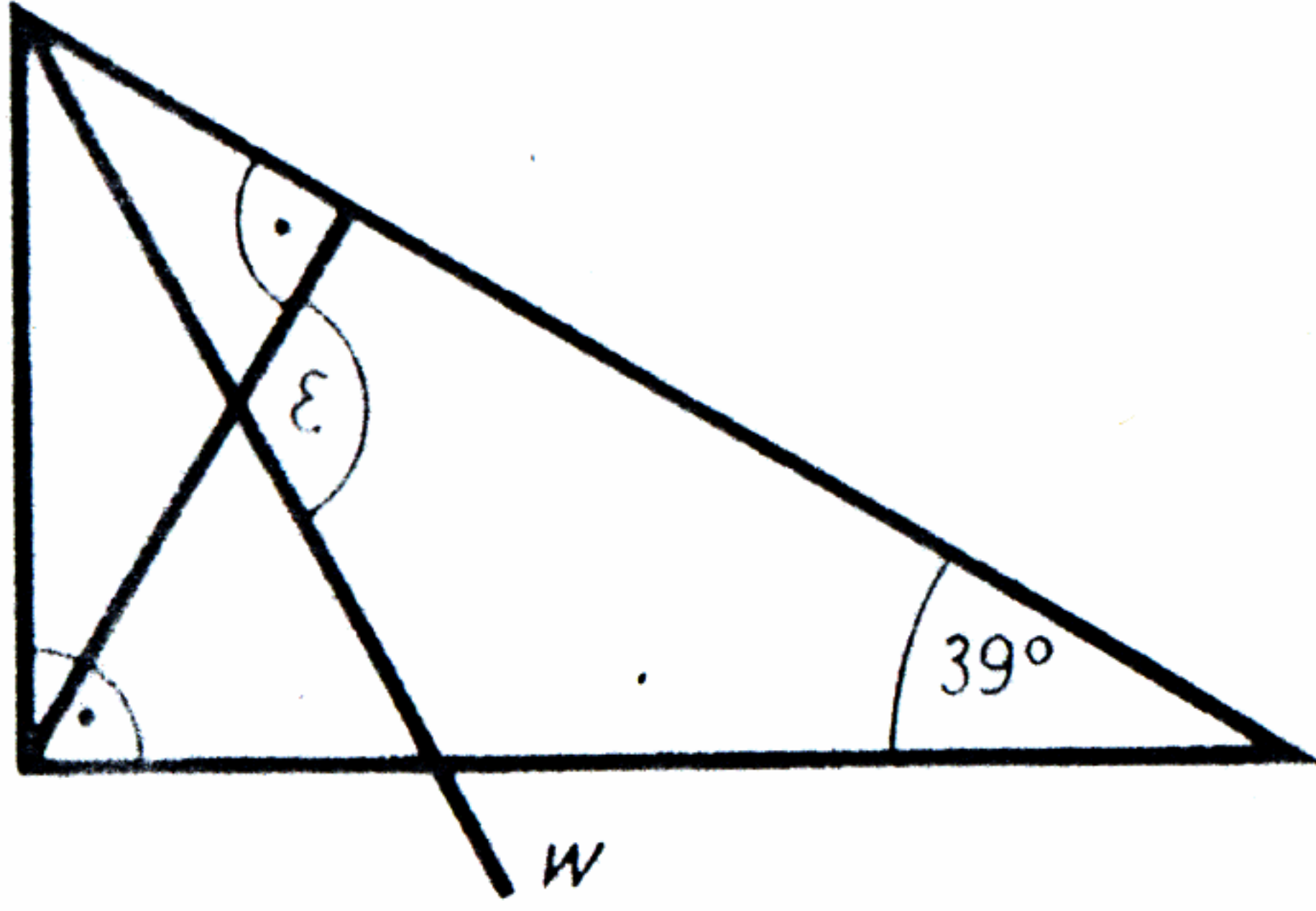

18 $F = ?$

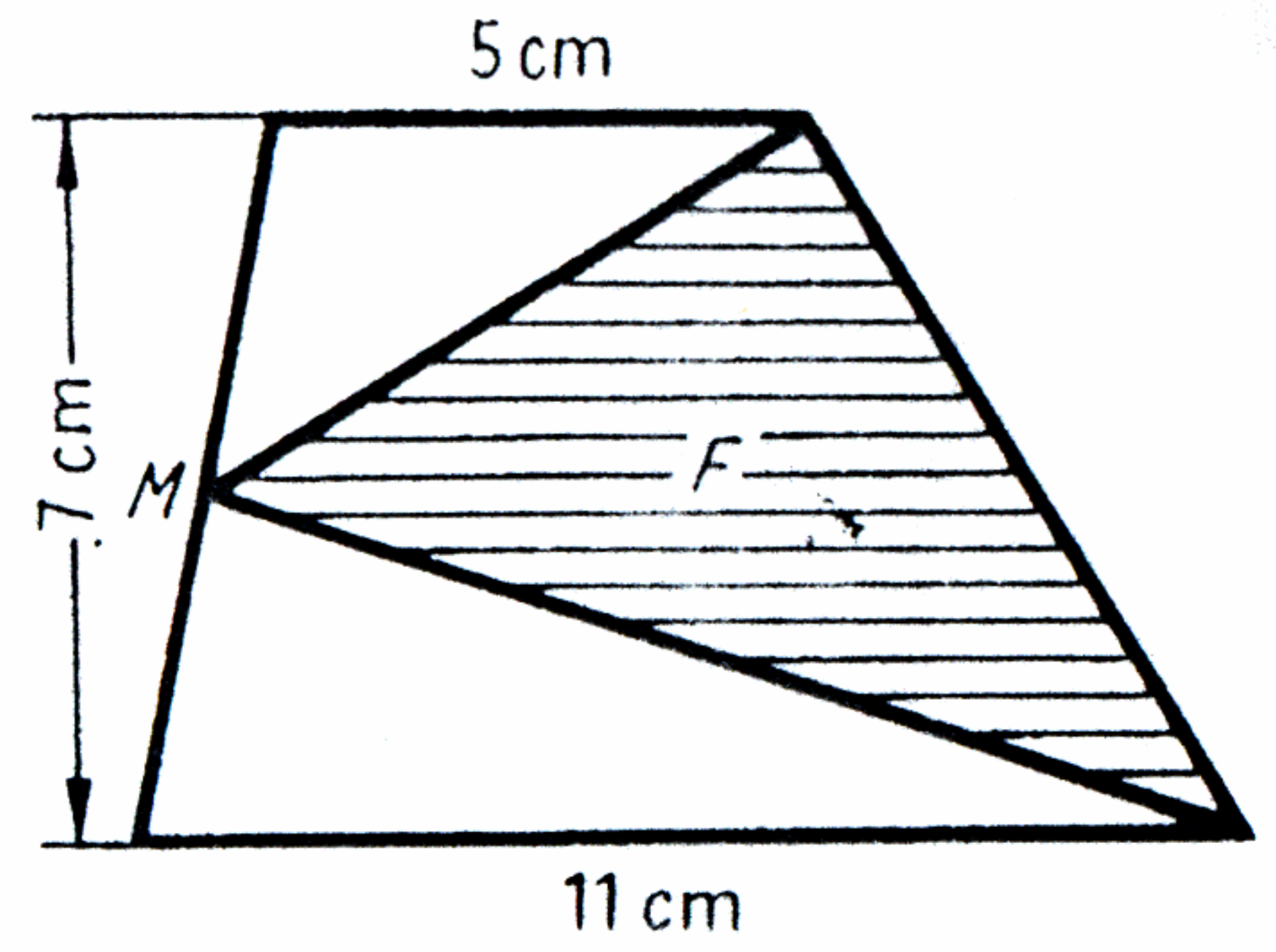

19 $\varepsilon = ?$

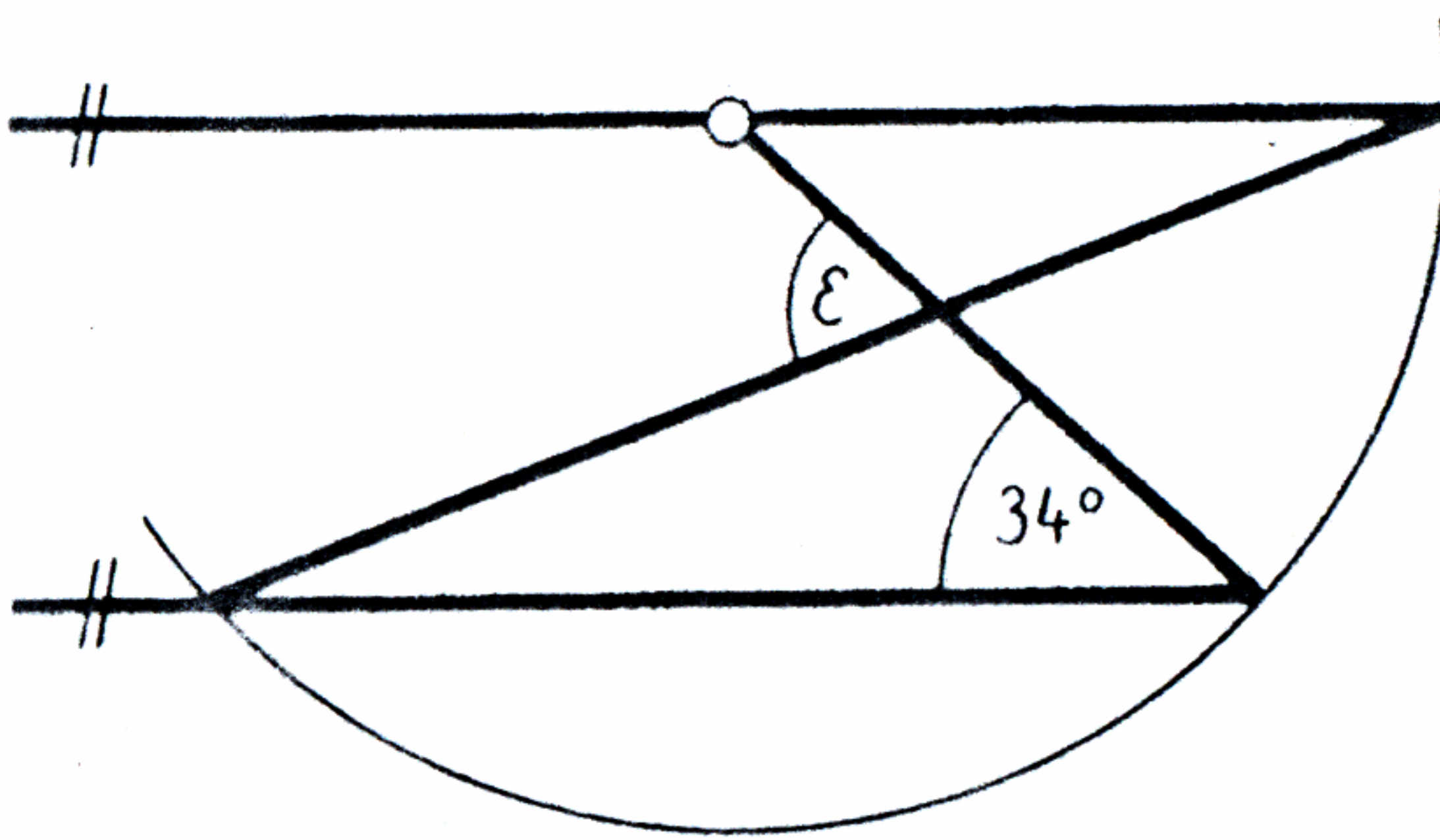

20 $A = B$
 $F = ?$

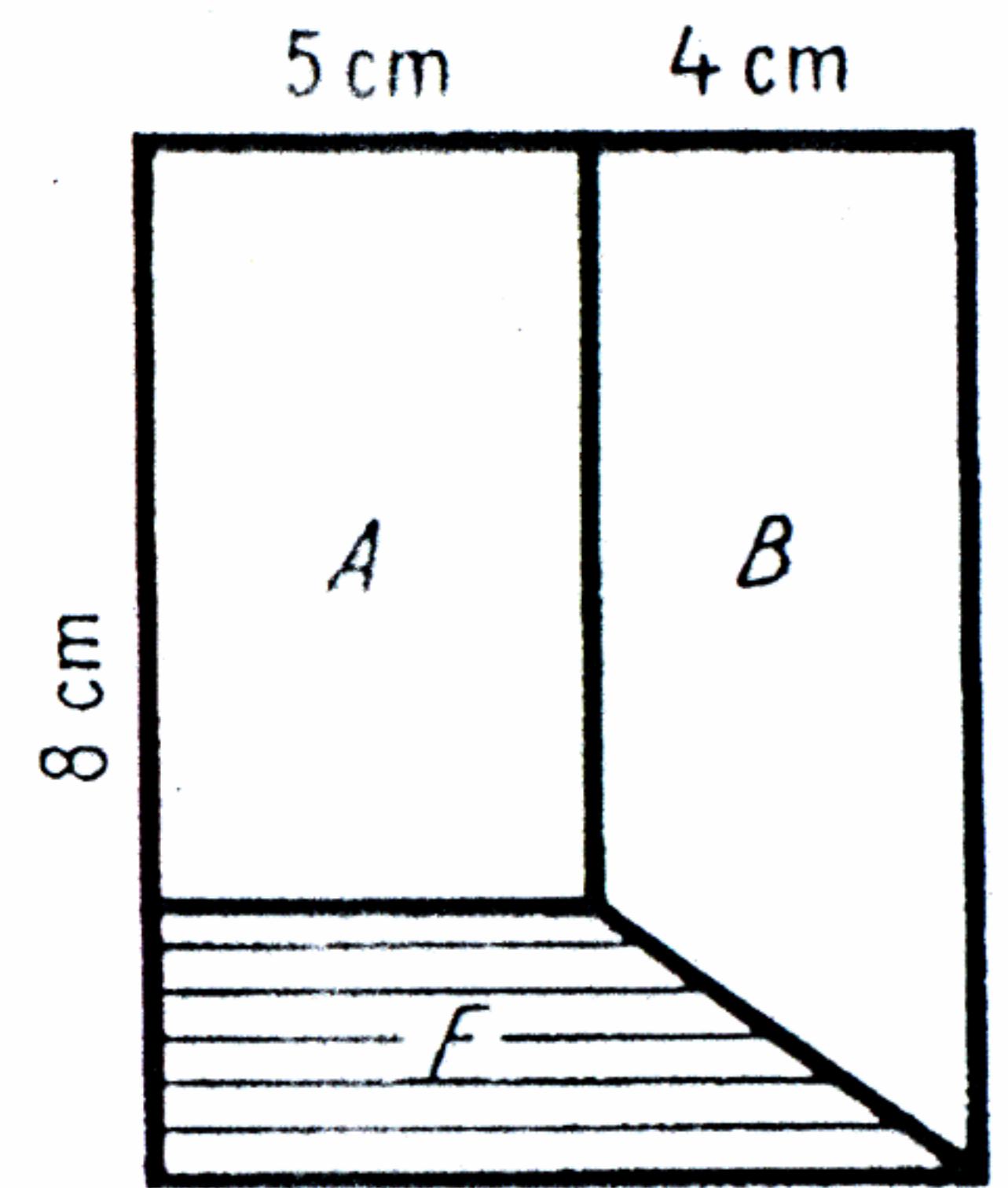

21

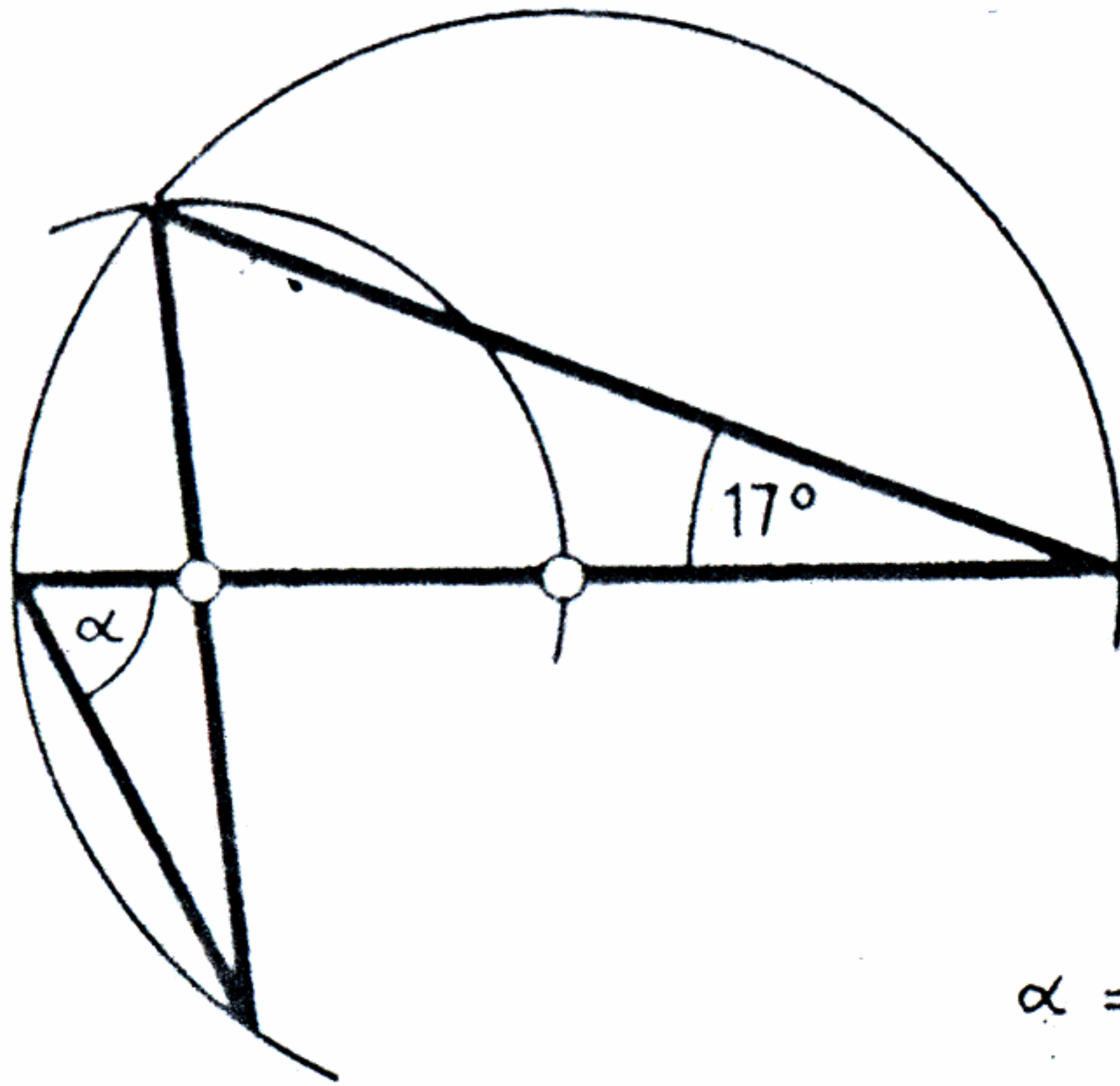

$\alpha = ?$

22 $F = ?$

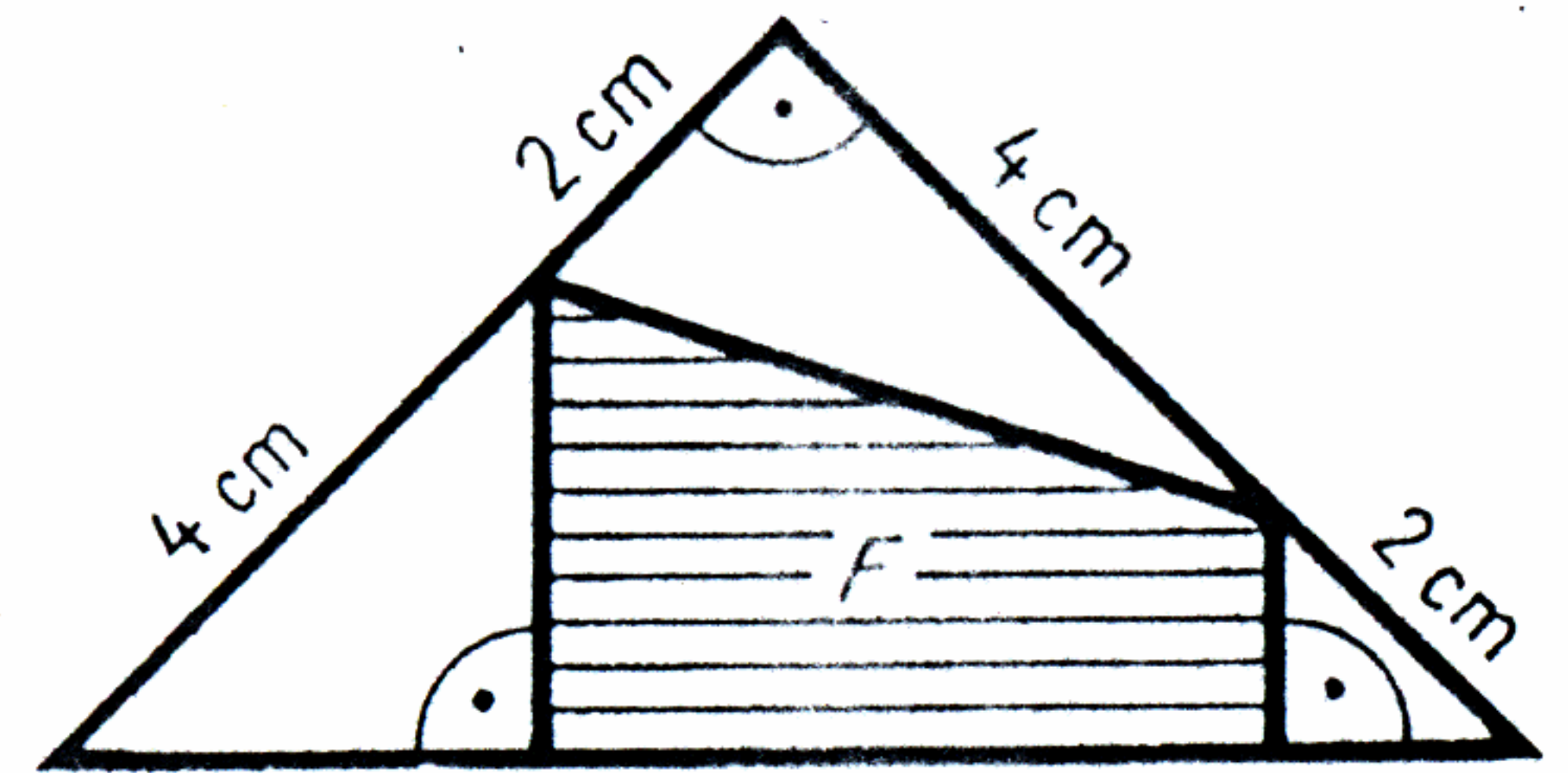

23

$\delta = ?$

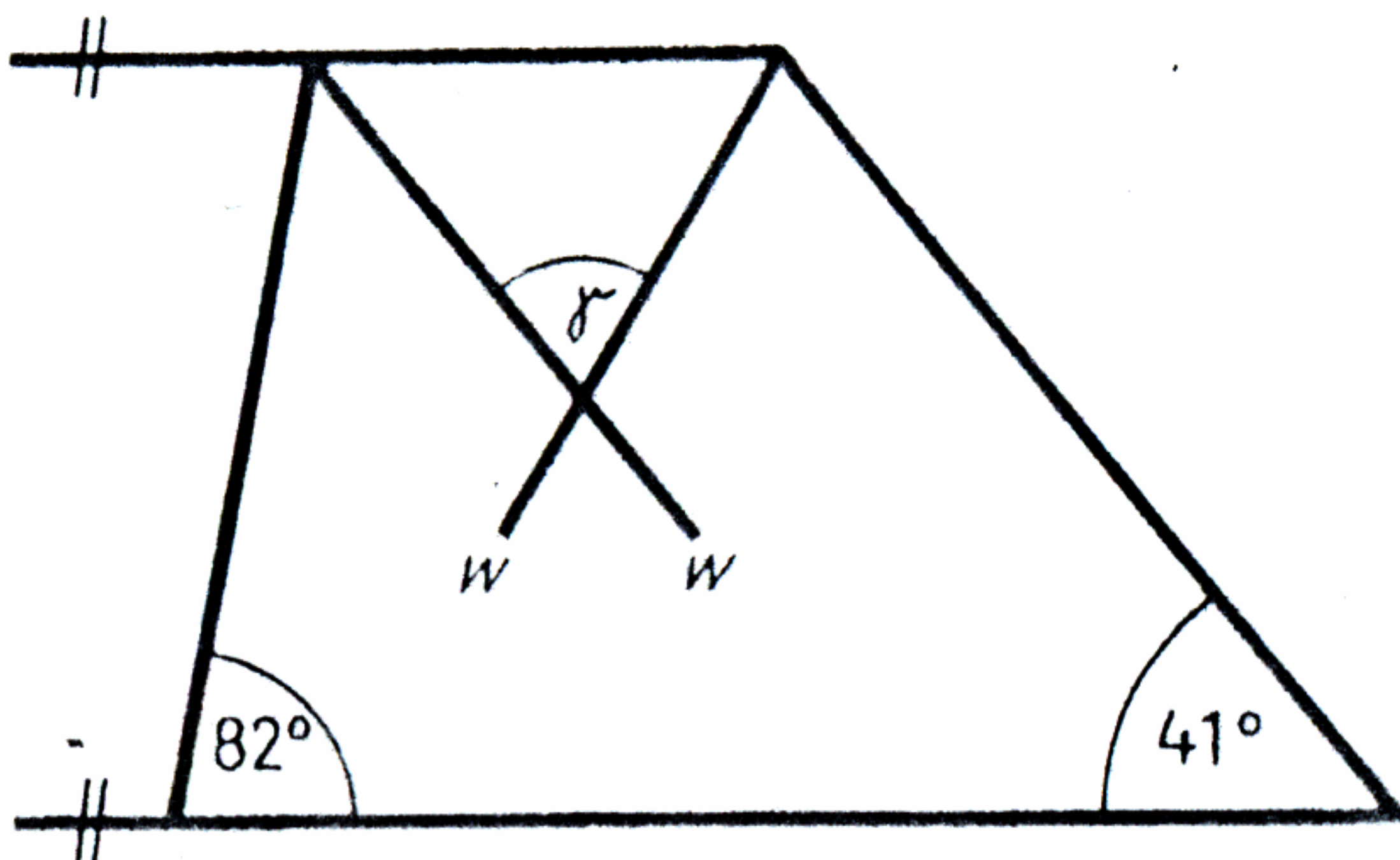

24 Die Flächenstücke A, B, C, D haben gleichen Umfang
 $D = ?$

